

MATERIAL HANDLING



HAND TRUCK • TROLLEY • WORKTAINER • SLIMCART • PALLET TRUCK
PALLET MESH • SHOPPING CART • E-DRIVE • CASTOR WHEEL

CASTOR & WHEEL COMPANY PROFILE

Castor & Wheel Singapore Private Limited established in 1983 is well known as one of the leading distributors and largest stockists for castor wheel products in the Asia regions.

Over the years, our firm has not only acquired a wealth of reputation but also experienced with emerging basic knowledge in solving technical problems to multi-mobility equipments catered in almost every field of industries such as: aircraft, shipbuilding, airport, hotels, shopping carts, medical apparatus, restaurants, kitchen appliances, electrical conductives, engineering, furnitures and many other mobility services in various institutions.

In recognition of 40 years of contribution to the various industries, Castor & Wheel Singapore has engaged with several reputable manufacturers of castor wheel products from around the world to complement and forge ahead with the advancement of technologies and innovations.

Complementing our existing product range is the inclusive of the latest material handling products and equipment.

To symbolize our service efficiency and sustain competitiveness, we have more than 16 operational distribution centers throughout Malaysia, Indonesia, Thailand, Vietnam and Philippines.



Castor & Wheel Singapore Pte Ltd (East Head Office)



Castor & Wheel Singapore Pte Ltd (West District)

NETWORKS

SINGAPORE

- Castor & Wheel Singapore Pte Ltd (East Head Office)
- Castor & Wheel Singapore Pte Ltd (West District)

MALAYSIA

- Ukai (Malaysia) Sdn Bhd (Head Office)
- Ukai (Malaysia) Sdn Bhd (Klang Branch)
- Ukai (Malaysia) Sdn Bhd (Melaka Branch)
- Ukai (Penang) Sdn Bhd (Penang Branch)
- Ukai (Johor) Sdn Bhd (Johor Branch)
- Ukai (Sabah) Sdn Bhd (Sabah Branch)
- C & W Marketing (M) Sdn Bhd (Kuala Lumpur Office)

INDONESIA

- PT Kastor & Wheel Indonesia (Jakarta Office)
- PT Batam Roda Jaya (Batam Office)

THAILAND

- Castor & Wheel (Thailand) Co Ltd (Bangkok Head Office)
- Castor & Wheel (Thailand) Co Ltd (Bowin Branch)

VIETNAM

- Castor & Wheel Vietnam Co Ltd (Ho Chi Minh Head Office)
- Castor & Wheel Vietnam Co Ltd (Hanoi Branch)

PHILIPPINES

- Castor & Wheel Philippines Inc (Manila Office)

WEBSITE: www.castorwheel.com

TABLE OF CONTENTS

PRESTAR PM, FOOT AND HAND PARKING HAND TRUCK SERIES	03
PRESTAR PB AND NB SERIES	04
PRESTAR PF AND NF SERIES	05
PRESTAR TF, NG AND PG SERIES	06
PRESTAR CASTER	06
PRESTAR WORKTAINER (WITHOUT DOOR)	07
PRESTAR WORKTAINER (WITH 2 DOORS)	08
PRESTAR SECURITY WORKTAINER	09
PRESTAR ROLL CAGE WHEEL MOUNTING POSITIONING	10
PRESTAR SLIM CART	11
LOGSMITH ELECTRIC PALLET HAND TRUCK	12
LOGSMITH HPT 3TONS STANDARD PALLET TRUCK	13
LOGSMITH HLP 2TONS LOW-PROFILE PALLET TRUCK	14
LOGSMITH HSC 3TONS DIGITAL WEIGHING SCALE PALLET TRUCK	15
LOGSMITH HDF 5TONS HEAVY-DUTY PALLET TRUCK	16
LOGSMITH HSS 2.5 & 3TONS STAINLESS STEEL PALLET TRUCK	17
LOGSMITH ELECTRIC TUG (WALKIE TOW TRACTOR) 1.5 TONS	18
LOGSMITH HAND TRUCK AND FOODCOURT TROLLEY	19 -20
LOGSMITH SHOPPING CART/ WALKWAY CASTORS	21
LOGSMITH PALLET MESH	22
TENTE E-DRIVE & AVG CASTOR	23
REACH TRUCK WHEELS	24
CASTOR WHEEL INTRODUCTION	25-26



PM Plastic Mesh SERIES

200kg

780 x 490 mm

160/180 mm

Ø100 mm

日本製
MADE IN JAPAN

PM-201-P
PM-201-WR
(Cool Grey)

P - Plastic Wheel Holder
WR - Metal Wheel Holder



PM-S201-P
PM-S201-WR
(Black)

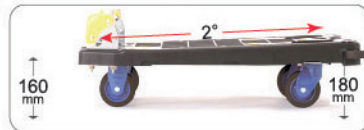

Platform elevated at an angle of 2 degrees

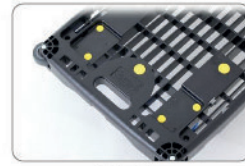

Stacking
(Possible to stable stacking)

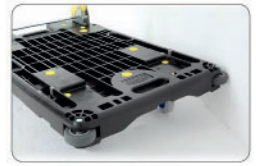

Corners Guiding
(Protection from damage)



One Hand Carry



Rolling Movement
(Roll and carry)

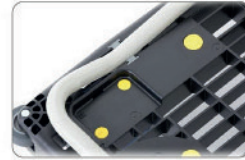

Lock-on Handle



4-Sides Grips

NEW DESIGN!

		Dimension (mm) (width x depth x height)	Platform Dimension (mm) (width x depth)	Weight (kg)
PM-201- P / WR	Folding Type With Silent Casters	790 x 505 x 900	670 x 490	9.5
PM-S201- P / WR	Folding Type With Silent Casters & Foot Brake System	835 x 505 x 900	670 x 490	11.1



FOOT & HAND

Simply press the foot pedal to apply or release the parking brake. It is also possible to mount stoppers afterward on hand truck that are already in service.

FOOT PARKING

Step onto the On-Brake pedal to engage stopper on the left and right wheels to parking position.

To release brake, simply step onto the Off-Brake pedal.



PB-S101-P
Folding handle type



PF-S301-P
Folding handle type



PG-S502
Fixed handle type



FL-S361
Folding handle type



NB-S101
Folding handle type



NF-S301
Folding handle type



NG-S401-8
NG-S401-6
Folding handle type

HAND PARKING

Grip the handle to release the brake. The brake engages automatically when the handle is released. This safe parking function ensures that the hand truck will not move unexpectedly while it is stopped.



PF-HP301C-P
Folding handle type



NF-HP301
Folding handle type



NF-HP307
Side-netting type

PB SERIES

Plastic Beauty Car

kg 150kg

710 x 455 mm

146 mm

Ø100 mm



Specially designed yellow protector that enhance safety and to prevent accident caused by problems such as jamming when raising the handle. The folding mechanism also helps protect against impact.

Plastic hand trucks combine lightness and strength.

Available in three different colours. Our plastic hand trucks are manufactured using injection molding machines at our own plant. Light and easy to handle, they are specially designed to withstand impacts. Choose from three colours to match your preference or the task at hand.

日本製
MADE IN JAPAN

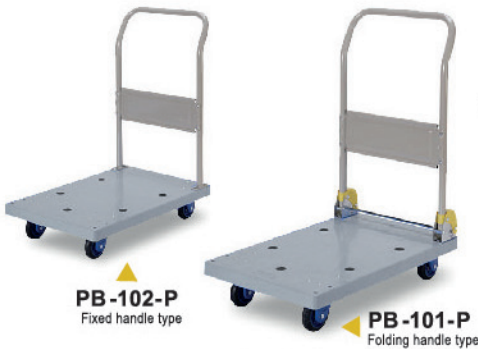

NB SERIES

New Beauty Car

kg 150kg

740 x 480 mm

134 mm

Ø100 mm



Transport loads with peace of mind.

All corners of the cargo platform are curved on the sides and protected with the soft rubber bumpers to absorb shocks in case of a collision when transporting loads.

Silent casters for reduced noise.

Models equipped with low noise casters are available for work situations where avoiding noise is important, such as transporting cargo in offices or at night. It is made of reinforced plastic to prevent collision which is suitable for food processing plants, or other similar environments.

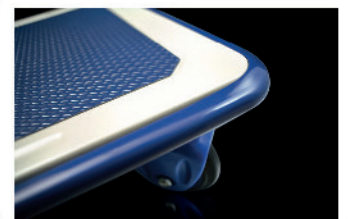
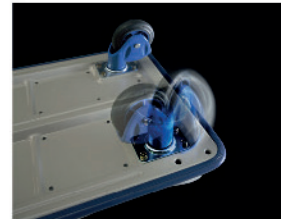



PF SERIES



300kg



900 x 600 mm



215 mm



Ø130 mm

日本製
MADE IN JAPAN

ブラウン ● (Cool Grey)

ブルー ● (Cool Blue)

イエロー ● (Cool Yellow)



Pursued platform for safety and easiness. Hand Truck has standard equipment for easy to carry with 2 hand places and 10 big non-slipping plugs on the platform. Safety is also improved by corner with round shaping.

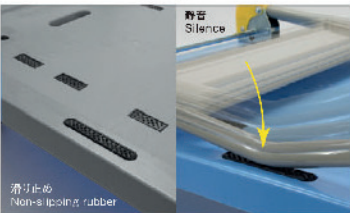

Non-slipping plugs & Silent cushion. We make a noise reduction possible with non-slipping plugs on the platform when you got the handle folded down.

Intensity enhancement with reinforced pipes. Intensity enhancement and weight saving has come true by inserting 2 reinforced pipes into the plastic platform.



PF-300-P
No-handle type

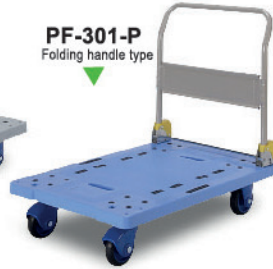

PF-301-P
Folding handle type



PF-302-P
Fixed handle type



PF-303-P
Fixed Front-rear dual-handle type



PF-314-P
Double Deck single-handle type



PF-307-P
Side-netting type



PF-307W-P
Double side-netting type



PF-305-P
Triple Deck dual-handle type



PF-304-P
Double Deck dual-handle type



PF-315-P
Triple Deck single-handle type



PF-327-P
Double Deck side-netting type



PF-333-P
Left-right dual-handle type

PHASING OUT SOON!

PHASING OUT SOON!

PHASING OUT SOON!

PHASING OUT SOON!

PHASING OUT SOON!

NF SERIES

New Fresh Car



300kg



910 x 610 mm



210 mm



Ø130 mm

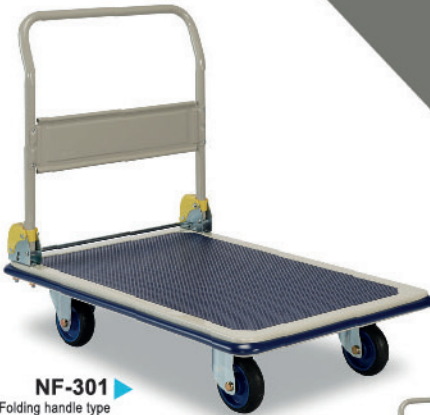

NF-301
Folding handle type



NF-302
Fixed handle type



NF-314
Double Deck single-handle type



NF-307W
Double side-netting type



NF-300
No-handle type



NF-303
Fixed Front-rear dual-handle type



NF-307
Side-netting type



NF-304
Double Deck dual-handle type



NF-305
Triple Deck dual-handle type



NF-315
Triple Deck single-handle type



NF-327
Double Deck side-netting type



NF-333
Left-right dual-handle type

PHASING OUT SOON!

PHASING OUT SOON!

PHASING OUT SOON!

PHASING OUT SOON!

PHASING OUT SOON!

TF Toughness Car SERIES



400kg



900 x 600 mm



220 mm



Ø130 mm



日本製
MADE IN JAPAN



PHASING OUT SOON!

TF-402
Fixed handle type



PHASING OUT SOON!

TF-403
Fixed Front-rear dual-handle type

NG New Grand Car SERIES



6 inch Castor
400kg



1240 x 790 mm



233 mm



Ø150 mm



8 inch Castor
500kg



1240 x 790 mm



288 mm



Ø200 mm

NG-400-6
NG-400-8
No-handle type



NG-401-6
NG-401-8
Folding handle type



NG-402-6
NG-402-8
Fixed handle type



NG-407-6
NG-407-8
Side-netting type



NG-403-6
NG-403-8
Fixed Front-rear dual-handle type

PHASING OUT SOON!



PHASING OUT SOON!

NG-433-6
NG-433-8
Left-right dual-handle type

PG Power Grand Car SERIES



600kg



1225 x 775 mm



310 mm



Ø200 mm



PG-500
No-handle type



PG-502
Fixed-handle type



PG-503
Fixed Front-rear dual-handle type

PHASING OUT SOON!

CASTERS

A VARIETY OF CASTERS ARE AVAILABLE FOR DIFFERENT APPLICATION AND PURPOSES.

5 INCH

178mm 11mm
55mm 100x56mm (80x80)
Ø130mm



WR - SERIES
STANDARD



4 INCH

123mm 9mm
33mm 82x40 mm
Ø100mm

178mm 11mm
55mm 100x56 mm (80x80)



P - SERIES
LOW-NOISE



123mm 9mm
33mm 82x40 mm



WORKTAINER WITHOUT DOORS

日本製
MADE IN JAPAN

DOUBLE-COATING CATION ELECTRO-DEPOSITION COATING + POWDER COATING

- ✓ Multi-functional Elegant Design
- ✓ High Quality & Environmentally Friendly
- ✓ High Volume Capacity & High Impact Plastic/Metal Base
- ✓ Ease Of Movement /Easy to Push
- ✓ Space-Saving Nesting Ability
- ✓ Standard Colour - Beige
- ✓ Other Colours available on Request



Assembled
Without Door
Metal Base



Folded
Without Door
Plastic Base



4つの静音構造。

4 POINTS OF SILENT (AS STANDARD EQUIPMENTS)



① BAR HOLDER



② BAR CAP



③ BAR RECEIVER



④ JOINT

NEW



6" Swivel c/w Directional-Lock
(Switchable from Swivel to Rigid)



Cross Bar With Hook

Mounting Method

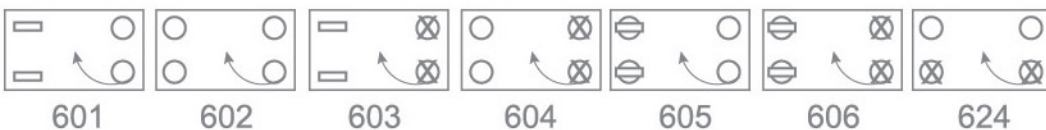

○ Swivel Caster ≡ Rigid Caster ⊗ Swivel Wheel-Brake ⊖ Swivel c/w Directional-Lock (Switchable from Swivel to Rigid)

WORKTAINER WITH 2 DOORS



日本製
MADE IN JAPAN



Plastic Base



Metal Base

NEW



6" Swivel c/w Directional-Lock
(Switchable from Swivel to Rigid)



Nesting



Additional Plastic Shelf
Plastic Base

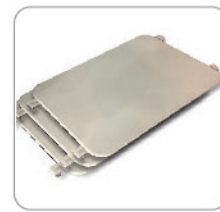

Optional Metal Shelf

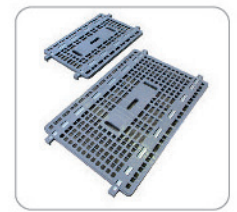

Optional Plastic Shelf

Worktainer		SPECIFICATION		LOAD CAPACITY (kg)		NET WEIGHT (kg)	
Without Door	With Door	Width (W) x Depth (D) x Height (H)		Plastic Base	Metal Base	Plastic Base	Metal Base
		Outer Dimension (mm)	Inner Dimension (mm)				
WT-80-60-17	WT-80-60-17(2DR)	800x600x1700	740x545x1450	400	500	36	39.5
WT-85-60-17	WT-85-60-17(2DR)	850x600x1700	790x545x1450	400	500	37	41
WT-85-65-17	WT-85-65-17(2DR)	850x650x1700	790x595x1450	400	500	38	42
WT-95-80-17	WT-95-80-17(2DR)	950x800x1700	890x745x1450	500	500	42.5	48
WT-11-80-17	WT-11-80-17(2DR)	1100x800x1700	1040x745x1450	500	500	45.5	51



SECURITY WORKTAINER

FULLY ENCLOSED WITH 2 DOORS AND OPENABLE ROOF TOP

日本製
MADE IN JAPAN

- High Quality, Ease of Movement
- Low Noise Level & Optional Shelves
- Environmentally Friendly
- Powder Coated Frame with Plastic Base
- Lockable Mesh Door & Roof
- Standard Colour - Beige



NEW



6" Swivel c/w Directional-Lock
(Switchable from Swivel to Rigid)



Optional Metal Shelf

Security Worktainer	SPECIFICATION		LOAD CAPACITY (kg)	NET WEIGHT (kg)
	Width (W) x Depth (D) x Height (H)			
	Outer Dimension (mm)	Inner Dimension (mm)		
WTS-85-65-17	850x650x1700	790x595x1450	500	62.5
WTS-11-80-17	1100x800x1700	1040x745x1450	500	75

Mounting Method

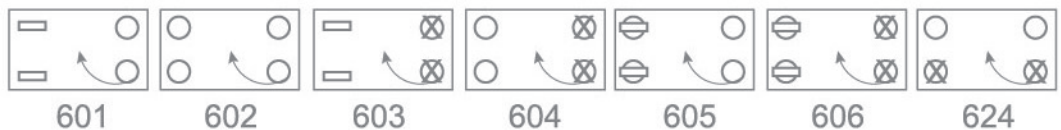

○ Swivel Caster □ Rigid Caster ⊗ Swivel Wheel-Brake ⊕ Swivel c/w Directional-Lock (Switchable from Swivel to Rigid)

WORKTAINER

CASTOR MOUNTING METHOD & SPECIFICATION



すぐれた防錆性能を発揮し、強さと美しさを保つダブルコーティング塗装。
過酷な環境下でもすぐれた防錆性能・耐候性能を発揮して、強度と美観をキープするダブルコーティング塗装。
粉体塗装はメラミン焼付塗装の約10倍の強度があり、屋外で使用しても光沢の劣化がほとんどありません。

The Worktainer is painted with a double-coating that provides superb anti-rust performance, and maintains the strength and cleanliness. The double-coating paint maintains the durability and appearance of the Worktainer providing superb rust-prevention and weathering performance, even in harsh environments. The powder coating provides a strength 10 times higher than a melamine baked finish, resulting in almost no degradation of gloss, even when used outdoors.

カチオン電着塗装とは？

被塗物を塗料にひたし自動車用の下塗り塗装工程として、隅々まで耐食性に優れた均一な塗膜を得る塗装システムです。

With the cationic electro-deposition coating?

Soaked cover lacquer ware into paint, and, as an automotive undercoating painting process, was corrosion-resistant to the every corner, and was superior; is uniform it is a painting system getting coating.

ベージュ(標準色)以外はオプションカラー
Colors other than beige are optional.
Standard color is beige

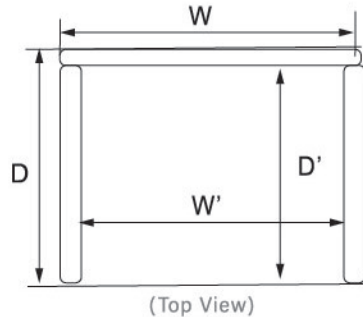
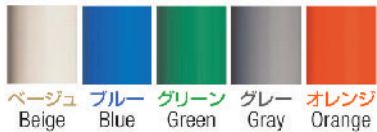

床板スチールタイプ
Steel base plate type

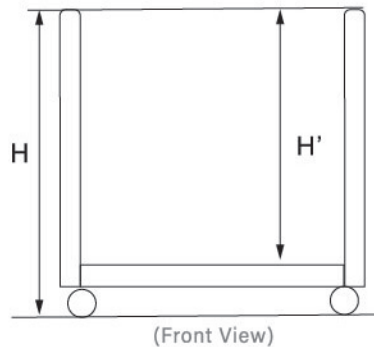

床板プラスチックタイプ
Plastic base plate type

高口口質。
High quality

NEW



6" Swivel c/w Directional-Lock
(Switchable from Swivel to Rigid)



6" Swivel Wheel Brake

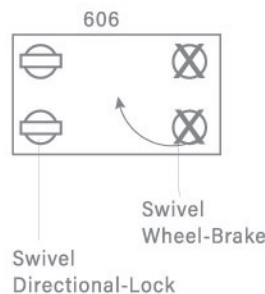

6" Swivel Caster



6" Rigid Caster

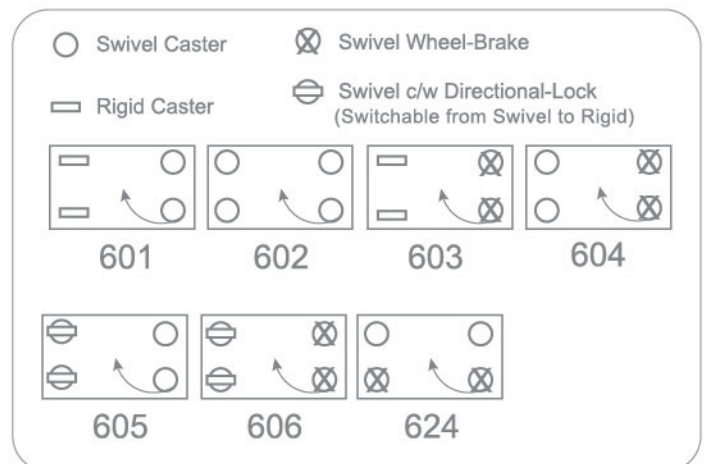



SLIM CART

日本製
MADE IN JAPAN

- ✓ Sturdy Configuration
- ✓ High Quality & Environmentally Friendly
- ✓ Easy Storage in Tight Places
- ✓ Low Noise Level & Optional Shelves

ネスティング5台可能な4輪スリムカート
4-Wheel Slim cart with 5 Nesting type

ブレーキ機能やターンロック機能も。

4輪 4SN

中間棚、床板、収納時 (ネスティング5台可能)
When the bottom plate storing (5 Nesting possible)



4SN
4 Wheels Slim Cart (Nestable)



6輪スリムカート、レギュラータイプ
6-Wheel Slim cart, Regular type

手軽に使えるレギュラータイプ。

Regular type that can be used easily.

6輪 6STS

積み上げタイプ 360°回転自在
Standard type 360° Rotatable



ギアロック式固定車
Gear lock type fixed caster



ブレーキペダル (ON/OFF)
Brake pedal (ON/OFF)



中間棚
(オプション)

Optional
Plastic Shelf

重ねて収納が可能。
Possible to storage
by stacking.



Optional Metal Shelf
for 6 wheels Slim Cart

Slim Cart		Size (mm) (length x width x height)	Loading Size (mm) (length x width x height)	Caster Ø (mm)	Load Capacity (kg)
4SN	4-wheels Slim Cart Nesting with Swivel Lock & Directional Lock	1020×480×1650	916×475×1364	130 x 4nos	300
6STS	6-wheels Slim Cart Stacking with Central Locking	1277×445×1500	1141×445×1285	130 x 2nos 100 x 4nos	500

ELECTRIC

ELECTRIC PALLET TRUCK 2.0 TONS • CE CERTIFIED



I	SPECIFICATION		LOGSMITH
2	Model		ET20MH-P
3	Operator type		Walkie
4	Load Capacity (kg)	Q	2000
5	Load Center (mm)	C	600
6	Wheelbase (mm)	Y	1202/1272
7	Service Weight (kg)		125/130
8	Overall Height (mm)	H1	1280
9	Lift Height (mm)	H2	195
10	Fork Height (Lowered) (mm)	H3	85
11	Overall Length (mm)	L1	1555/1625
12	Overall Width (mm)	B	540/680
13	Fork Size (mm)	L2	540x1150/680x1220
14	Travel Motor		750w
15	Travel Speed (laden/unladen)	km/h	4/4.5
16	Max.Gradeability (laden/unladen)	%	5%/20%
17	Battery Voltage/ Capacity V/Ah	V/Ah	24V/20Ah Li-Battery
18	Turning Radius (mm)	R	1352/1422
19	Lift Motor		500w



WARRANTY

3 months warranty against manufacturer's defects not covering wear and tear or breakage which is being misused beyond the recommended load capacity or any kind of unforeseen dispute on the products.

12 months warranty on the hydraulic pump unit not covering misuse or any kind of unforeseen dispute on the products.

- Lithium Battery
- Powerful and Portable
- Upright Driving
- Minimum Maintenance

• Handle

Ergonomics Designed! Smart and Comfortable.

- Accelerator
- Reversing button
- Lowering releasing lever
- Lifting button

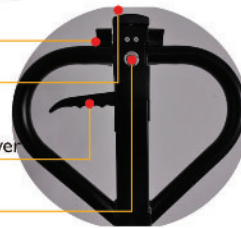

• Driving Unit

- UK PG controller
- High Quality Motor
- Reliable Driving Wheel

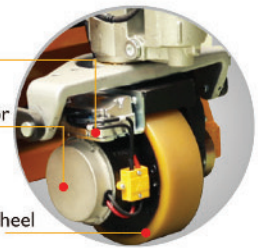

	Length Fork mm	Length Fork mm	Total width mm	Fork Height lowered min mm	Fork Height raised max mm	Fork Width standard mm	Internal Fork standard mm	Load Capacity kg
LOG-C-ET20MHP-1220*680	1220	1560	680	85	195	160*50	360	2000



Manual Break Release



Key Switch



Portable Lithium Battery



Quick Charge



Fork

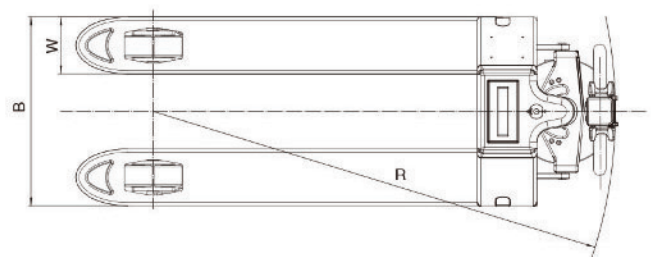
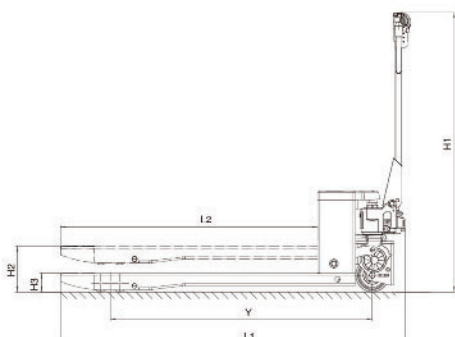

HPT

MANUAL PALLET TRUCK • CE CERTIFIED STANDARD TYPE • 3.0 TONS

- AC Pump • Fully sealed galvanized hydraulic unit housing
- Powder coated chassis made of high-grade steel 3.75mm thickness Mn Steel
- Single valve cartridge for easy maintenance.
- Lead-in and lead-out wheels and rollers reduce less damages to pallets.
- Handle with rubber grip • Pump stroke: 13/14 strokes
- Lift Piston 35mm thickness
- 6 mm Mn Steel for pallet truck lifting cap

WARRANTY

3 months warranty against manufacturer's defects not covering wear and tear or breakage which is being misused beyond the recommended load capacity or any kind of unforeseen dispute on the products.

12 months warranty on the hydraulic pump unit not covering misuse or any kind of unforeseen dispute on the products.



LIFTING CAP
6MM THICKNESS

LIFT PISTON
35MM THICKNESS



Standard Single Nylon Load Wheel 74*93 Available in Stocks



Optional Single PU Wheel Load Wheel 74*93 Available By Request



Optional Tandem Double Nylon Load Wheel 78*70 Available in stock



Optional Tandem Double PU Load Wheel 80*70 Available By Request

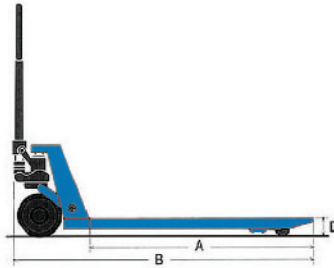

	Length Fork (A) mm	Length Fork (B) mm	Outer width (C) mm	Fork Height lowered min (D) mm	Fork Height raised max (D) mm	Fork Size standard (E) mm	Inner Fork standard (F) mm	Truck Weight kg	Load Capacity kg
HPT 301N1200*685	1200	1570	685	80	190	160*60	365	72-75	3000
HPT 301N1200*550	1200	1570	550	80	190	160*60	230	72-75	3000
HPT 301U1200*685	1200	1570	685	80	190	160*60	365	72-75	3000
HPT 301U1200*550	1200	1570	550	80	190	160*60	230	72-75	3000
HPT 301N0800*685	800	1170	685	80	190	160*60	365	68-70	3000
HPT 301N0800*550	800	1170	550	80	190	160*60	230	68-70	3000
HPT 301U0800*685	800	1170	685	80	190	160*60	365	68-70	3000
HPT 301U0800*550	800	1170	550	80	190	160*60	230	68-70	3000

Steering Wheel

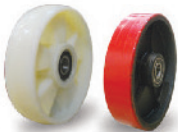

	material / profile	mm	mm	mm	mm	core	bearing	kg
WWN200*50	Nylon / Flat	200	48	20	45	nylon	6204-2RS	800
WWU200*50	PU / Flat	200	50	20	45	cast iron	6204-2RS	800

Load Wheel



WWN74*93 (Single)	Nylon /Round	74	93	20	93	nylon	6204-2RS	800
WWN78*70 (Tandem)	Nylon/Round	78	70	20	70	nylon	6204-2RS	800
WWU74*93 (Single)	PU /Flat	74	93	20	93	cast iron	6204-2RS	800
WWU80*70 (Tandem)	PU/Flat	80	70	20	70	cast iron	6204-2RS	800



Grease Nipple



1A



1A



2B



3C

HLP

MANUAL PALLET TRUCK 2.0 TONS LOW-PROFILE • CE CERTIFIED

- AC Pump • Fully sealed galvanized hydraulic unit housing
- Single valve cartridge for easy maintenance
- Powder coated chassis made of high-grade steel
- Suitable for extreme low-height application
- Handle with rubber grip
- Pump stroke: 8 strokes

WARRANTY

3 months warranty against manufacturer's defects not covering wear and tear or breakage which is being misused beyond the recommended load capacity or any kind of unforeseen dispute on the products.

12 months warranty on the hydraulic pump unit not covering misuse or any kind of unforeseen dispute on the products.



	Length Fork (A) mm	Length Fork (B) mm	Total width (C) mm	Fork Height lowered min (D) mm	Fork Height raised max (D) mm	Fork Width standard (E) mm	Internal Fork standard (F) mm	Truck Weight kg	Load Capacity kg
HLP 202N1220*685	1220	1560	685	55	145	160*46	365	65-70	2000
HLP 202N1220*550	1220	1560	550	55	145	160*46	230	65-70	2000

Steering Wheel

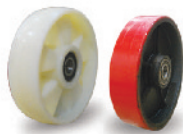

	material / profile	mm	mm	mm	mm	core	bearing	daN	kg
WWN160*50	Nylon / Flat	160	50	20	45	nylon			800
WWU160*50	PU / Flat	160	50	20	45	cast iron			800

Load Wheel



WWN050*70	Nylon / Flat	50	70	17	70	nylon			650
WWU050*70	PU / Flat	50	70	17	70	cast iron			650



HSC MANUAL PALLET TRUCK • CE CERTIFIED WITH DIGITAL WEIGHING SCALE • 3.0 TONS

- With digital scale combines controlling function of very accurate weighing system.
- AC Pump. Pump stroke: 15 strokes
- Fully sealed galvanized hydraulic unit housing.
- Single valve cartridge for easy maintenance.
- Four high quality alloy load cells ensures accuracy in full capacity range.
- High quality indicator with battery, and easy to simple to operate.
- Handle with rubber grip. • Lift Piston 35mm thickness
- 6 mm Mn Steel for pallet truck lifting cap
- 3.75mm thickness Mn Steel for pallet truck frame and body

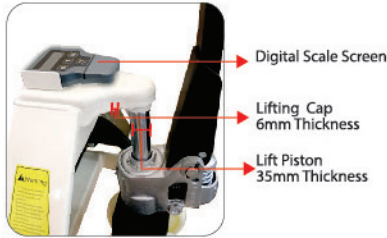

WARRANTY

3 months warranty against manufacturer's defects not covering wear and tear or breakage which is being misused beyond the recommended load capacity or any kind of unforeseen dispute on the products.

12 months warranty on the hydraulic pump unit not covering misuse or any kind of unforeseen dispute on the products.



Standard Single Nylon Load Wheel 72*93 Available in Stocks



Optional Single PU Wheel Load Wheel 74*93 Available By Request



Optional Tandem Double Nylon Load Wheel 72*70 Available in stock



Optional Tandem Double PU Load Wheel 74*70 Available By Request

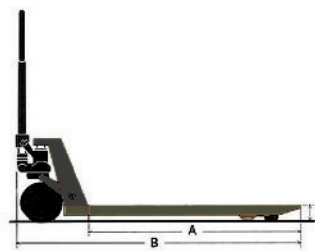

	Length Fork (A) mm	Length Fork (B) mm	Outer width (C) mm	Fork Height lowered min (D) mm	Fork Height raised max (D) mm	Fork Size standard (E) mm	Inner Fork standard (F) mm	Truck Weight kg	Load Capacity kg
HSC301N1200*550	1200	1570	550	80	200	180*60	190	118	3000
HSC301N1200*685	1200	1570	685	80	200	180*60	325	118	3000
HSC302N1200*550	1200	1570	550	80	200	180*60	190	118	3000
HSC302N1200*685	1200	1570	685	80	200	180*60	325	118	3000

Steering Wheel

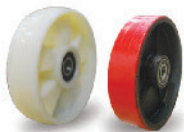

	material / profile	mm	mm	mm	mm	core	bearing	daN	kgs
WWN200*50	Nylon / Flat	200	93	20	50	nylon	6204-2RS	800	

Load Wheel



WWN74*93 (Single)	Nylon / Round	74	93	20	93	nylon	6204-2RS	800	
WWN78*70 (Tandem)	Nylon / Round	78	70	20	70	nylon	6204-2RS	800	
WWU74*93 (Single)	PU / Flat	74	93	20	93	cast iron	6204-2RS	800	
WWU78*70 (Tandem)	PU / Flat	78	70	20	70	cast iron	6204-2RS	800	

Grease Nipple



HDF

MANUAL PALLET TRUCK 5.0 TONS HEAVY-DUTY • CE CERTIFIED



- Welded pump • Engineered from homogenous steel thickness 4mm.
- Designed with temperature controlled robotic welds
- Customized fork length can be prolonged from 650mm ~ 2500mm
- Ergonomic handle with neutral setting and spring enable handle to an upright position when released
- Pump Stroke: 22 strokes

Remarks:

- Please note that when the fork length is prolonged, load capacity will eventually reduce. Eg: Fork length exceeds 2000mm, max load cap: 2000kg.

WARRANTY

3 months warranty against manufacturer's defects not covering wear and tear or breakage which is being misused beyond the recommended load capacity or any kind of unforeseen dispute on the products.

12 months warranty on the hydraulic pump unit not covering misuse or any kind of unforeseen dispute on the products.



	Length Fork (A) mm	Length Fork (B) mm	Total width (C) mm	Fork Height lowered min (D) mm	Fork Height raised max (D) mm	Fork Width standard (E) mm	Internal Fork standard (F) mm	Truck Weight kg	Load Capacity kg
LOG-C-CBY5N1220*680	1220	1560	685	85	195	180*60	325	170	5000



Load Wheel	material / profile	mm	mm	mm	mm	core	bearing	kgs
WWN085*78	Nylon / Flat	80	70	20	78	nylon	6204-2RS	900



Steering Wheel	material / profile	mm	mm	mm	mm	core	bearing	kgs
WWN200*50	Nylon / Flat	200	50	20	45	nylon	6204-2RS	900



Standard Tandem Double Nylon Load Wheel 85*78 Available By Request

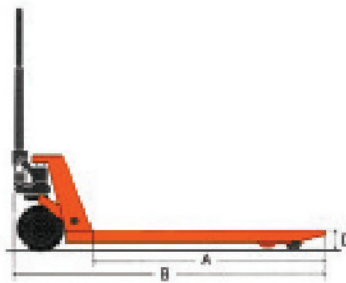

HSS MANUAL PALLET TRUCK 2.5 & 3.0 TONS

STAINLESS STEEL (SUS304) • CE CERTIFIED



- All hydraulic pallet truck parts are made of stainless steel including hydraulic pump, fork frame, handle, push rod, bearing, pin and bolt, etc.
- Suitable for food stuff, chemicals, pharmaceuticals and other aggressive environment
- The ergonomic handle safely protects the operator's hands
- Polyamide steer and load rollers with stainless steel ball bearing
- Pump stroke: 14 strokes

WARRANTY

3 months warranty against manufacturer's defects not covering wear and tear or breakage which is being misused beyond the recommended load capacity or any kind of unforeseen dispute on the products.

12 months warranty on the hydraulic pump unit not covering misuse or any kind of unforeseen dispute on the products.

	Length Fork (A) mm	Length Fork (B) mm	Total width (C) mm	Fork Height lowered min (D) mm	Fork Height raised max (D) mm	Fork Width standard (E) mm	Internal Fork standard (F) mm	Truck Weight kg	Load Capacity kg
HSS252N1150*550	1150	1490	550	80	190	160*60	230	82	2500
HSS252N1150*685	1150	1490	685	80	190	160*60	365	87	2500



Load Wheel
WXN72*93

material / profile
Nylon / Flat



mm
72



mm
93



mm
20



mm
93



core
nylon



bearing
SS



kgs
750



Steering Wheel
WXN180*50

Nylon / Flat

mm
180

mm
50

mm
20

mm
45

nylon

SS

kgs
800

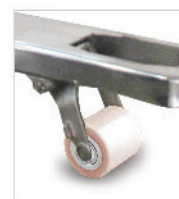
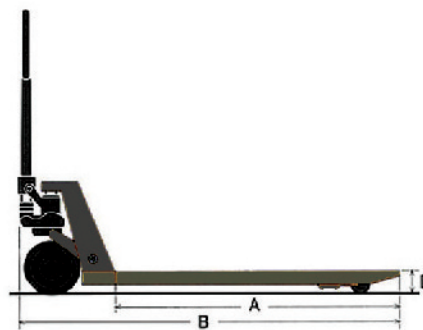
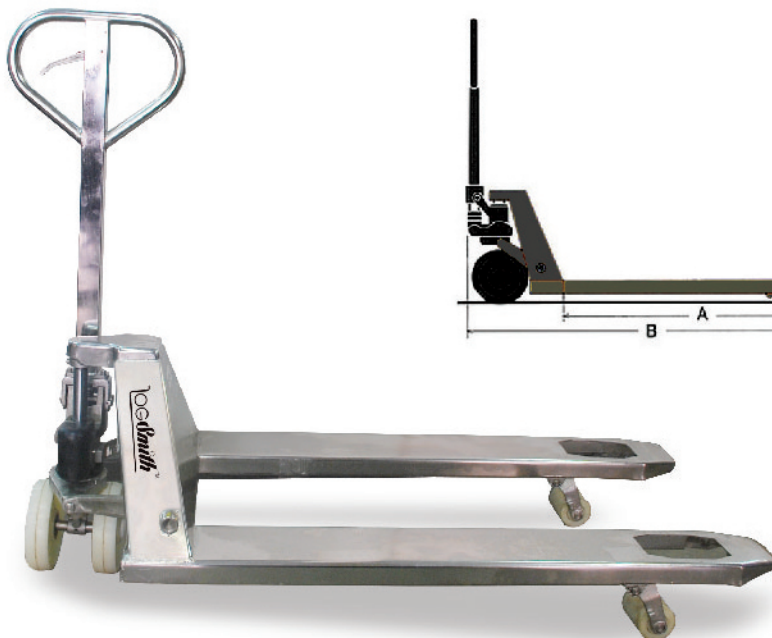

Standard Single Nylon Load Wheel 72*93 Available in Stocks



Optional Tandem Double Nylon Load Wheel 72*70 Available By Request



C-QDD15-E-TUG

**ELECTRIC TUG (WALKIE TOW TRACTOR) 1.5 TONS
MEDIUM DUTY • CE CERTIFIED**

- DC Power-Drive, Hydraulic Steering • Lithium Battery : 24v/20 Ah
- Smart, durable, impact design, electric-power and efficient application for supermarket, factories, hospitals, airport and multi-usages

WARRANTY

12 months warranty against manufacturer's defects including battery but not covering wear and tear or breakage which is being misused beyond the recommended tugging capacity or any kind of unforeseen dispute and damages on the products.



Portable Charging Pack



Sample Application

TECHNICAL SPECIFICATION

Product Code	: C-QDD15-E-TUG
Electric Drive	: DC • 24V/20Ah
Battery Pack	: Lithium (Portable Charging Pack)
Charging Time	: Recommended 2 hours full charge
Usage Duration	: Continuous 2 hours at full charge
Power Capacity	: 1500kg
Operate Type	: Walkie
Speed Action	: Reverse & Forward (Max 4km/h)
Drive Wheel	: 2* Ø250*90mm • Pneumatic Tyre
Load Wheel	: 2* Ø70*45mm • Polyurethane/ Swivel
Overall Length	: 1255-1315-1345mm
Overall Width	: 520mm
Drawbar Pull	: Rated 200N
Service Weight	: 98 kg
Steering System	: Manual
Brake System	: Mechanical
Safety Button	: Auto Spring forward safety function
Snail Function	: Enable at constant slow speed
Towing Hook	: Built-in for different application
Frame Finish	: Steel, powder coated (Plastic Cover)

TUGGING PERFORMANCE (IN KG)

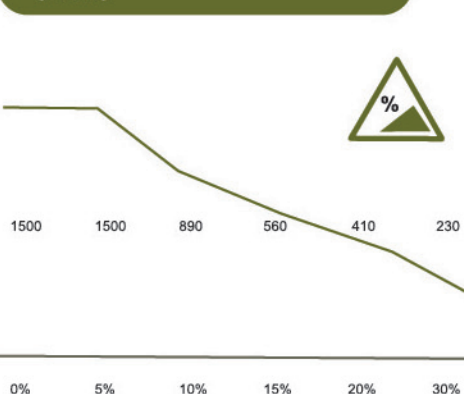

*Measured with any trolley with 4 castor wheels 150mm.

new

OEM CHINA JOINABLE TROLLEY

MULTI-PURPOSE AND PORTABLE JOINABLE TROLLEY

BRANDS	LOGSMITH
LOAD CAPACITY	120 KG PER PIECE
WHEEL DIAMETER	100 MM
PLATFORM MATERIAL	PLASTIC
PLATFORM SIZE	600 MM X 400 MM
COLOUR	BLUE

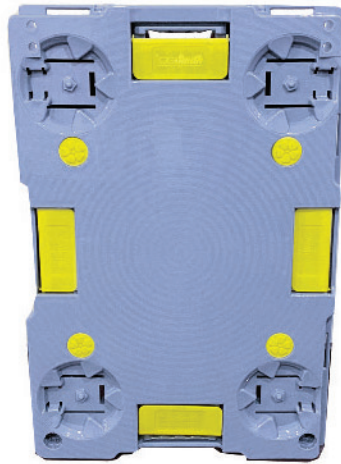

LOG-SK010S-BL (FRONT VIEW)
STANDARD WITHOUT HANDLE
COLOUR: BLUE



LOG-SK011M-BL (BACK VIEW)
STANDARD WITH HANDLE
COLOUR: BLUE

LOG-SK010S-BL

STANDARD WITHOUT HANDLE

SMART JOINABLE (BY WIDTH & LENGTH) STACKABLE AND MULTI-USAGE
4 PCS SWIVEL • 3" TPR CASTERS WHEELS

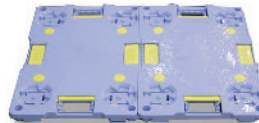
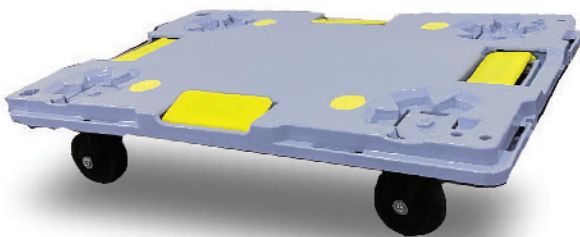

JOINABLE BY WIDTH



JOINABLE BY LENGTH



STACKABLE

LOG-SK011M-BL

WITH OPTIONAL RETRACTABLE AND ADJUSTABLE HANDLE

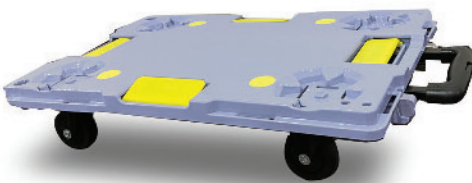

POSITIONING: 90° PUSHING ACTION



POSITIONING: 45° PULLING ACTION

SAKURA SERIES

LOG-SK010S-BL - 4 pieces Swivel casters with 3" TPR Wheel Ball bearing (Without Handle)

- Smart-connecting and compact system helps to joint 2 - 4 pcs or even into a bigger platform size

LOG-SK011M-BL - 2 Swivel 2 Rigid casters with 3" TPR Wheel Ball bearing (With Handle)

- Handle retractable and adjustable to 3 levels for pulling and pushing comfort
- Handle extended height to 930mm

- Platform Height: 136mm (without handle)
- Platform Size: 400 x 600mm
- Deck Thickness: 30mm
- Net Weight: 3.88kgs

- High Quality PP Material
- Holes Silencer designed to reduce noise
- Safety Load Capacity: 100kg
- Max Load Capacity: 120kg

PLASTIC HANDTRUCK FOOD COURT TROLLEY

日本製 MP001 BLUE / YELLOW MADE IN JAPAN AUTHENTIC MINI HAND TRUCK

ミニプラスチックカー

- Size: (L) 600 x (W) 385 x (H) 750 mm
- Caster Size: 75mm 2 Swivel, 2 Rigid
- Load Capacity: 100 kg
- Colour: Yellow or Blue
- Weight: 5.6 kg
- Material: Plastic



new

OEM CHINA HANDFOLD HANDLE TROLLEY

Collapsible Handle (Hand Operated)



SK6005-GR
Supported with 5 Castors

SK3505-RD

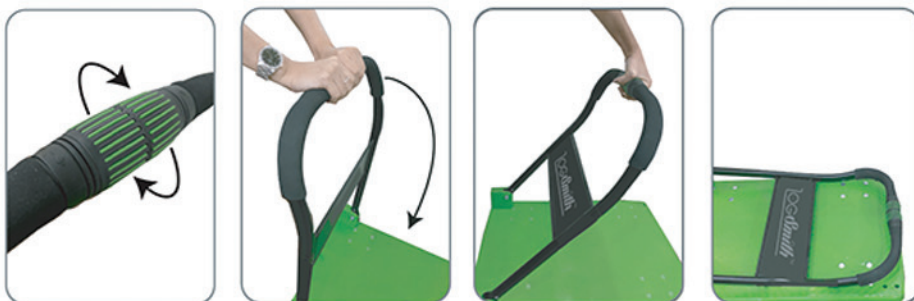

Handfold Handle	Platform Face (mm)	Floor Height (mm)	Handle Height (mm)	Deck Thickness (mm)	Deck Height (mm)	Castor (mm)	Net/ Gross (kg)	Load Capacity (kg)
SK1804-GRY	730 x 490	140	870	36	160	100	10 / 11	180
SK3505-GRY	900 x 600	200	960	40	200	125	14 / 15	350
SK6005-GRY	1100 x 600	200	960	50	169	125	25 / 26	600

OEM CHINA FOODCOURT TROLLEY (Triple Decker)

Applicable to Foodcourt, restaurant, hotel, hawker centre and all F&B caterings



OPTIONAL GARBAGE BIN



SK030B-BIN
(30L)

SK015B-BIN
(15L)

SK100B-FC

- Deck Size: (L) 950 x (W) 500 mm
- Height between 2 Decks:
- Garbage Bin: Optional
- Load Capacity: 100KG
- Handle Height: 900 mm
- Deck Thickness: 60 mm
- Castor Size: 100 mm TPR
- Net/ Gross: 12/13

SK120B-FC

- Deck Size: (L)1070 x (W) 505 mm
- Height between 2 Decks: 280 mm
- Garbage Bin: Optional
- Load Capacity: 120KG
- Handle Height: 900 mm
- Deck Thickness: 60 mm
- Castor Size: 100 mm TPR
- Net/ Gross: 14/15

SHOPPING TROLLEY

Shopping Trolley Casters

- Walkway castor designed for universal shopping trolley.
- Housing made of galvanized pressed-steel
- Thickness 2.5mm
- Double ballrace swivel head - hole fitting

Different kinds of wheel designed for various application

- Eg. Single Groove
Double Groove
Triple Groove
Single Spring Dish (Left or Right)
Double level (Left and Right)



ETH-001AOT0212L
970x570x1085mm



ETH-001UYT210L
1005x585x985mm



ETH-001-TQ-2
1515x580x1030mm



SHOPPING TROLLEY ACCESORIES



Baby Seat



Plastic Child Seat
Belt (Optional)



Handle Tube
with
Store Name



Advertising
Billboard

ETH-001-LH-12
1080x600x1105mm



WALKWAY CASTERS



236DGU125S12
Hole Fitting Swivel
Double Groove PU



237TGU125S12
Hole Fitting Swivel
Triple Groove PU



235SGU12512
Hole Fitting Swivel
Single Groove PU



238SDU125S12
Hole Fitting Swivel
Single Side-Disk PU Right/Left

PALLET MESH

STACKABLE STORAGE CONTAINER

Key featured for pad locking to ensure against theft, spring hinges with extra security and fastener.

6mm thickness steel rods electro-welded at high intensities at 50mm pitch for extra impact resistance.

Robust U channel steel base frame fully welded hot dip galvanized or zinc finished. Deep grooved legs provide a claw-like grip exceptional to enable stability for multi-layer stacking.

Handy, convenient, cost efficient in the sense that they are portable, durable, collapsible, stackable and provides better space utilization for better material handling.

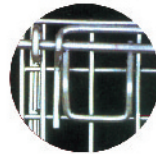

OPTIONAL: BLUE PVC COVER



Stackable mounting
Assemble with castor wheel on request

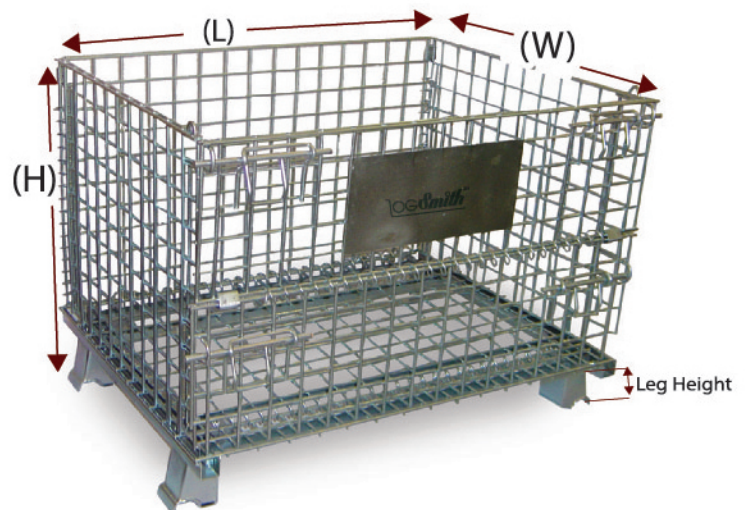

Models	External Dimension (mm)			Mesh (mm)		Leg Height (mm)	Stackability (layers)	Volume m ³	Unit Weight (kg)	Load Cap (kg)
	Width (W)	Length (L)	Height (H)	Wire	Pitch					
PALLETMESH -3	600 (24")	800 (32")	650 (26")	6	50	100 (4")	4	0.22	29	800
PALLETMESH -4	650 (26")	900 (36")	700 (28")	6	50	100 (4")	4	0.40	38	1000
PALLETMESH -5	800 (32")	1000 (40")	850 (34")	6	50	100 (4")	4	0.52	47	1200
PALLETMESH -7	1000 (40")	1200 (48")	900 (36")	6	50	100 (4")	4	0.84	66	1500
PALLETMESH -9	1200 (48")	1400 (56")	950 (38")	6	50	100 (4")	4	1.29	87	1600

TENTE

MADE IN GERMANY

E-drive Motorized System

The core of this drive system is a DC gear motor that transmits its power to the drive wheel.

The TENTE e-drive 1 system assists the user to move beds with heavy loads in an easier way. The starting and moving in forward and backward direction as well as the stopping is clearly facilitated. In addition to the easier handling, time can be saved and days of user sickness caused by the high stress can be minimised.

TECHNICAL DATAS

Installation height:	170 mm
Length:	max. 315 mm (emergency release actuated)
Width:	190 mm
Height (retracted):	140 mm
Maximum surface unevenness:	± 15 mm
Lifting force / downforce:	400 N
Weight:	6 kg
Protection grade:	IP X4



Get heavy loads moving effortlessly with this efficient starting assistance

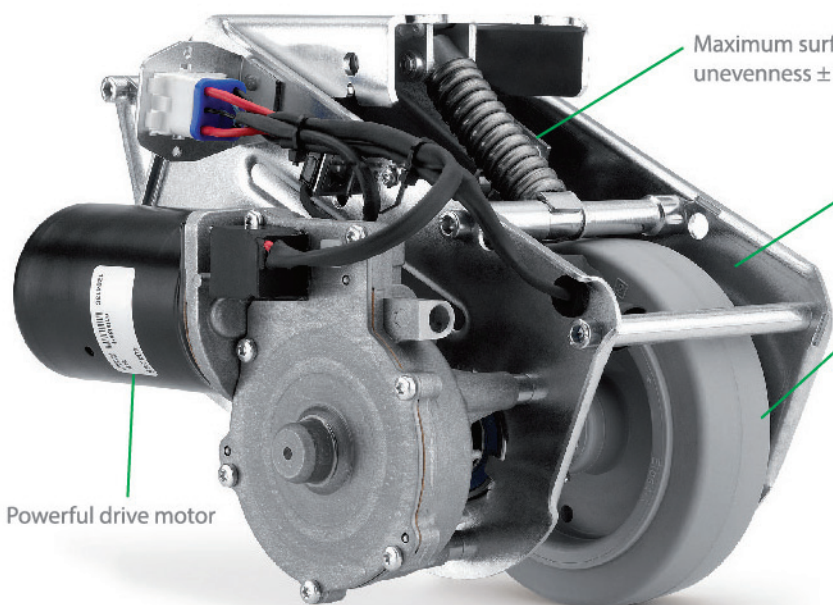

Maximum surface unevenness ± 15 mm

Housing made of pressed steel, zinc plated

Replaceable wheel
UFF: material solid rubber, non-marking, Shore 63 A Ø 125 mm

Powerful drive motor



TUV Certified
The performance standard of these castors even surpasses the requirements of the regulations set out in European standard DIN EN 12531.

APPLICATION EXAMPLES FOR E-DRIVE

Intralogistic

- Picking trolleys
- Parcel trolleys
- Special transport trolleys for e.g. carbody parts, tools, components

Hotel

- Hotel service trolleys
- Laundry trolleys
- Luggage trolleys

Hospital

- Food distribution trolleys
- Induction trolleys
- Surgery tables

Catering

- Food distribution trolleys
- Induction trolleys



AVG Castor Series 814W (Self-Aligned)

Swivel castor with automatic directional stability 180° or 360° and wheel brake Stainless Steel version
Series 8145, Swivel Castor
Series 8148,

Swivel castor with automatic directional stability 180° or 360°



Highly maintenance-friendly due to open precision ball bearings in the swivel head, allowing relubrication

Easy to apply castor brake operates on the principle of a ballpoint pen

Housing made of stainless steel

Wheel centre made of polyamide

Precision ball bearing, sealed

Tread made of elastic-tyre, non-marking



NEW INTRODUCTION OFFER!

REACH TRUCK WHEELS

Complete set of TOYOTA FBR 6/7

at a very attractive prices and bulk discount available!

Complete new wheel sets or custom rebonding services is now available.

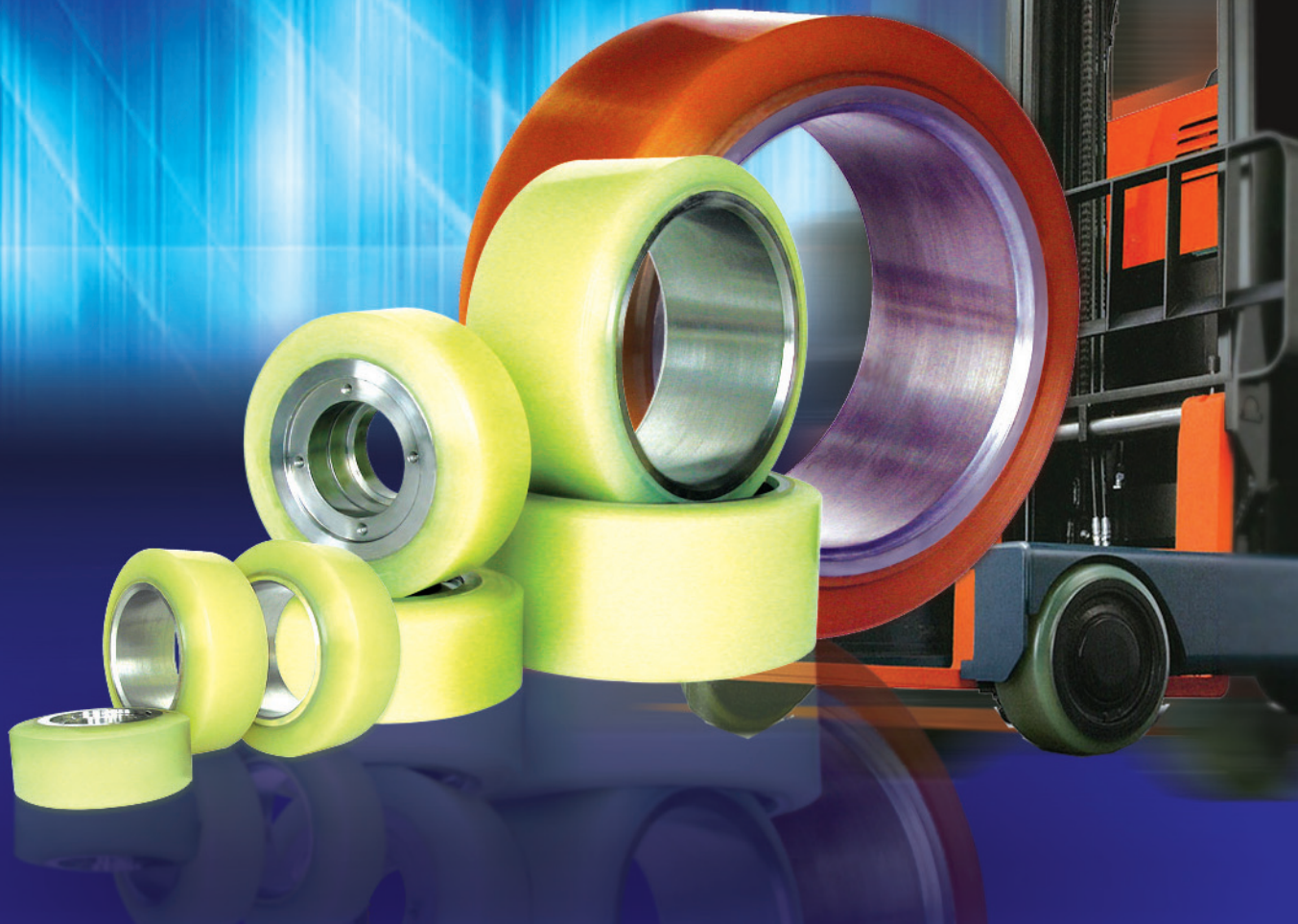

	Drive Wheel (mm)	Load Wheel (mm)	Castor Wheel (mm)
Toyota 6FBR 1.5 Tons Reach Truck	330 x 194 x 145	254x 190 x 120	178 x 127 x 73
Toyota 7FBR 1.5 Tons Reach Truck	330 x 194 x 145	254 x 190 x 120	150 x 80 x 80

CASTOR INTRODUCTION

TENTE

GERMANY



Hospital & Care Beds (Electric Conductive / Antistatic)



Super Heavy Duty (Up to 20,000 kg load)

THOS
MANOEUVRE AT EASE
SINGAPORE



Scaffolding Castor (USA, Europe & Australia Design)



Floor Lock (100, 125, 150, 200mm)



Steel Wheel (V · U · Y · Groove)

FOOTMASTER
KOREA



Leveling Castor (Standard, Stainless Steel, ESD)



Shock-Absorbing (Automotive Car Plant)



AGV/ Robotic (Dual Swivel Head)



JAPAN



JM/ JH Series (JIS Compliance)



Low Height Heavy Duty (Height: 57mm/ 63mm)



Pneumatic Air / Airless (Tire 4 PLY)

colson
USA/ EUROPE



Singletech (Medical Application)



STO Design (120 ~ 150 kg)

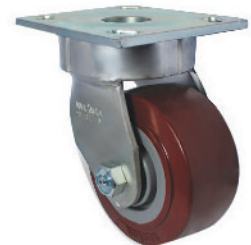

IMPAK Kingpinless (Load: 320~520 kg)

MUYTONS
INDIA



Forged Precision Bearing
Up to 25000 lbs

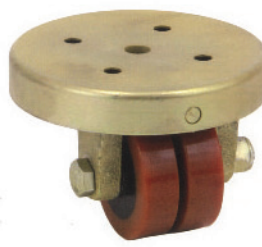

Low Profile 50mm
Heavy Duty 160 ~ 270 kg



Jacking Castor
Side-winding Operation



HD Truck Lock
Various Sizes



LEVINA 5370/5380 (Design for all applications)



LINEA 5940 (Medical Application)



SMILES 5520 (Furniture Castor)



PT Design Polytech Various Mounting (Stainless Steel, Electric Conductive)



Friction Ring, other mountings (Stainless Steel, Electric Conductive)



Round & L-Bumper Made of PVC

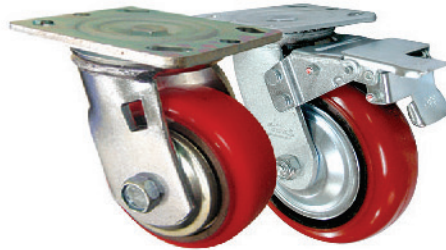

HD (PU Round Profile) USA & Korean 4 Series



HD Spring-Loaded (Single or Double Spring)



HD Stainless Steel (INOX BB)



Swivel & Rigid (Total Brake) Available Left Side & Right Side



HD Low Profile Machine Castor



Adjustable E-Lock Floor Lock 60, 75, 100, 125, 150, 200



Special for angle bar (Nylon, PU or Rubber Wheel)

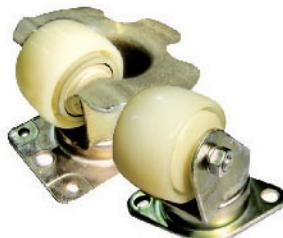

Air Cargo & Conveyor (Diamond Shape Plate/ Toe Guard)

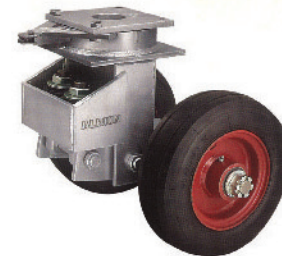

Aviation Ground Equipment (Load Up to 20,000 lbs)



Customized Castor (Engineering Design)



High Temperature -40°C to 280°C Short time:300 (Max Speed 4 Kph)

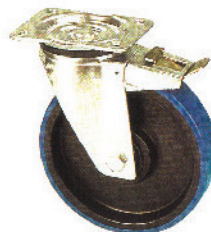

High Quality PU Wheels (Roller Bearing)



Continental Elastic (Precision Ball Bearing)



Ball Transfer Unit (Conveyor System)

CASTORWHEEL.COM

CASTOR & WHEEL

CASTOR & WHEEL SINGAPORE PTE LTD

EAST DISTRICT (HEAD OFFICE)

29 Kaki Bukit Place, Singapore 416207

Tel: (65) 6745 6944

Fax: (65) 6745 6945

Email: singapore@castorwheel.com

www.castorwheel.com

WEST DISTRICT

4 Tuas Link 2 Singapore 638553

Tel: (65) 6863 6944, 6863 6940

Fax: (65) 6863 6947

Email: west@castorwheel.com